

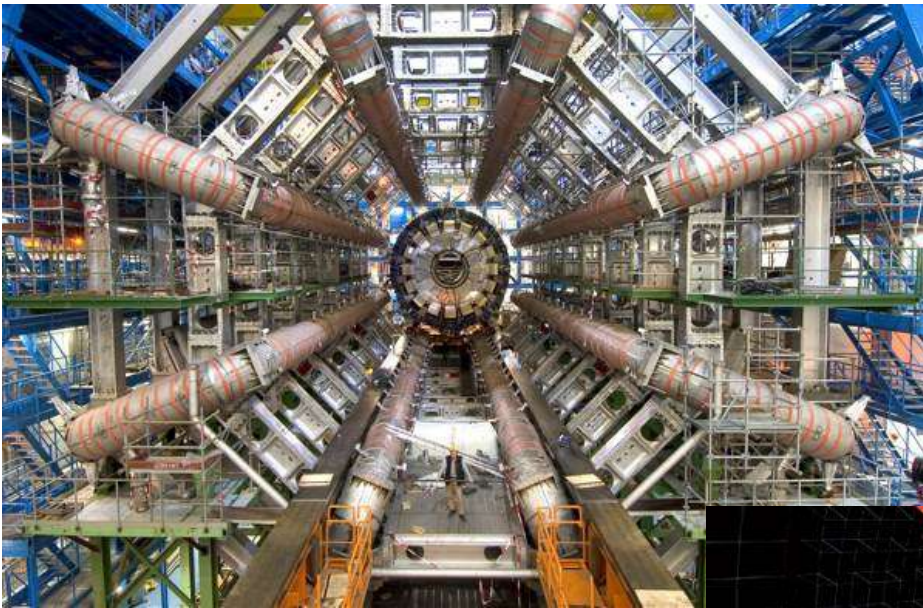

James M. Hill

Physics Handbook

2012 - 2013



- Equations, Variables, and Units
- Physical Constants
- Solar System Data
- Metric System

Mr. P. MacDonald

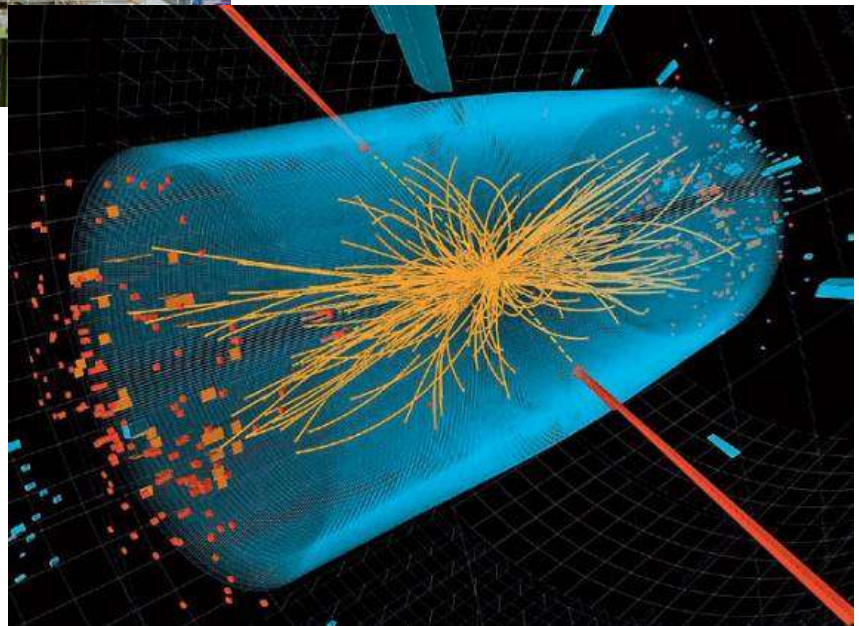

D-T Graph Analysis

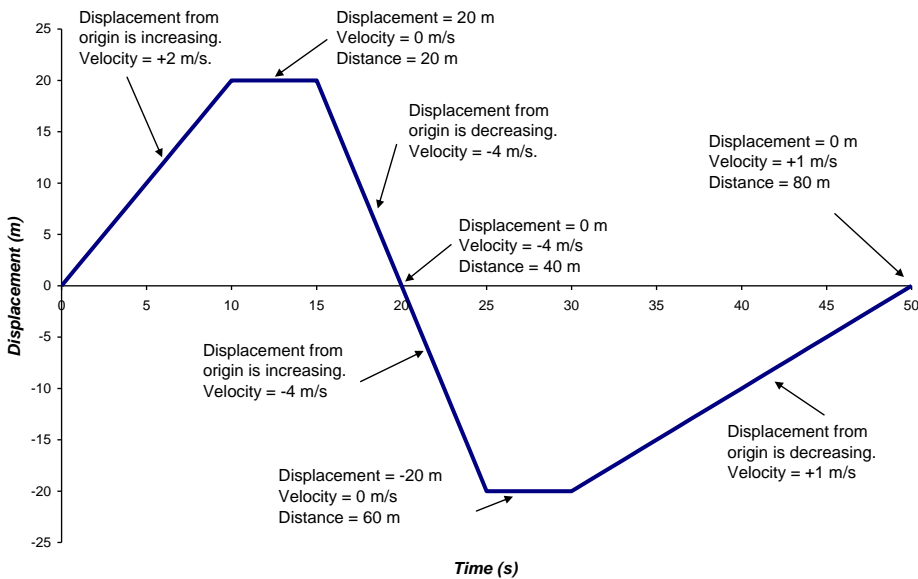

- Slope at any point is the instantaneous velocity.
- Sign of the slope indicates the direction the object is travelling.
- Distance is the sum of the displacements in both directions.
- Average *velocity* is the object's *displacement* divided by the time.
- Average *speed* is the object's *distance* divided by the time.

V-T Graph Analysis

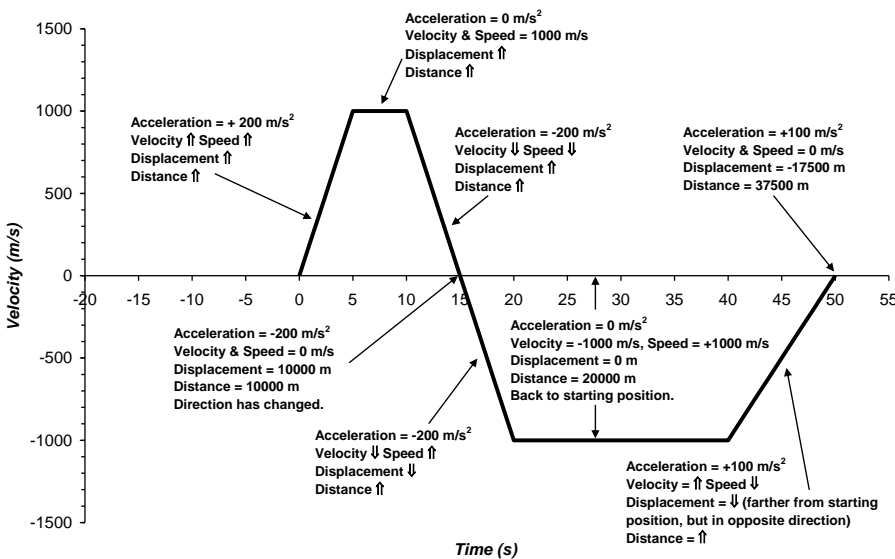

- Slope at any point is the instantaneous acceleration.
- Sign of the slope indicates the direction of the acceleration *not* the object.
- Distance travelled during a time interval is the sum of the areas contained between the graph and the time-axis.
- Displacement is the total area of the top minus the total area of the bottom.
- Average *velocity* is the object's *displacement* divided by the time.
- Average *speed* is the object's *distance* divided by the time.

******In the equations that follow all variables that are vectors could have a horizontal and vertical component. You have to remember to analyze each dimension independently if the problem warrants.******

Mathematical Addition of Vectors

Symbol	Quantity (Unit)	Symbol	Quantity (Unit)
\vec{R}	Resultant	\vec{A}, \vec{B}	Arbitrary Vectors
R_E or R_x	Horizontal component of resultant (E = Eastern)	A_E or A_x	Horizontal component of arbitrary vectors (E = Eastern)
R_N or R_y	Vertical component of resultant (N = Northern)	A_N or A_y	Vertical component of arbitrary vectors (N = Northern)
θ	Angle made with horizontal ($^\circ$)		

! Look very carefully at the trigonometry when calculating vector components.

$R_x = A_x + B_x + \dots$	$R_y = A_y + B_y + \dots$	$ \vec{R} = \sqrt{R_x^2 + R_y^2}$	$\theta = \tan^{-1} \left \frac{R_y}{R_x} \right $
---------------------------	---------------------------	------------------------------------	---

Kinematics - Mathematical Analysis & Projectile Motion

Symbol	Quantity (Unit)	Symbol	Quantity (Unit)	Symbol	Quantity (Unit)	
<i>anything_f</i>	Final value	<i>anything</i>	Magnitude	<i>d</i>	Distance (m)	
<i>anything_o</i>	Initial Value	\vec{d}	Displacement (m)	<i>v_{sp}</i>	Average Speed (m/s)	
<i>anything_x</i>	Horizontal component	\vec{v}_{avg}	Average velocity (m/s)	<i>t</i>	time (s; refers to a time interval)	
<i>anything_y</i>	Vertical component	\vec{v}	Velocity (m/s)	θ	Angle made with horizontal (degrees, °)	
<i>anything_E</i>	Eastern component	\vec{a}	Acceleration (m/s ²)	Δ	Change in (final - initial)	
<i>anything_N</i>	Northern component	\vec{g}	9.81 (m/s ² ; surface of the Earth)			
$\vec{d} = \vec{d}_f - \vec{d}_o$	$\vec{v}_{avg} = \frac{\vec{d}}{t}$	$v_{sp} = \frac{d}{t}$	$\vec{v}_{avg} = \frac{\vec{v}_f + \vec{v}_o}{2}$	$\vec{a} = \frac{\vec{v}_f - \vec{v}_o}{t}$	$\vec{d}_f = \vec{d}_o + \vec{v}_o t + \frac{1}{2} \vec{a} t^2$	$\vec{v}_f^2 = \vec{v}_o^2 + 2\vec{a}\vec{d}$
$v_{ox} = \vec{v} \cos \theta$	$v_{oy} = \vec{v} \sin \theta$	$ \vec{v} = \sqrt{v_{fx}^2 + v_{fy}^2}$	$\theta = \tan^{-1} \left \frac{v_y}{v_x} \right $			

Dynamics - Forces, Impulse, Torque, Momentum, & Circular Motion

Symbol	Quantity (Unit)	Symbol	Quantity (Unit)	Symbol	Quantity (Unit)				
\vec{F}_{net}	Net force (N)	\vec{F}_T	Force of Tension (N)	\vec{J}	Impulse (N·s)				
\vec{F}_A	Force applied (N)	\vec{F}_N	Normal Force (N)	\vec{p}	Momentum (kg·m/s)				
\vec{F}_g	Force of gravity (N)	\vec{F}_c	Centripetal Force (N)	\vec{p}_{oT}	Initial total momentums (kg·m/s)				
\vec{F}_f	Force of friction (N)	<i>m</i>	Mass (kg)	\vec{p}_{fT}	Final total momentums (kg·m/s)				
\vec{F}_s	Restoring Force (N)	μ	Coefficient of friction (no units)	<i>f</i>	Frequency (Hz)				
\vec{a}_c	Centripetal Acceleration (m/s ²)	<i>T</i>	Period (s)	<i>r</i>	Circular & Orbital Radius (m)				
τ	Torque (N·m)	F_{\perp}	Perpendicular Component of Force (N)	<i>v</i>	Circular Speed (m/s)				
<i>k</i>	Spring Constant (N/m)								
$\vec{F}_{net} = \sum Forces$	$\sum \vec{F} = \sum m \times \vec{a}$	$\vec{F}_{net} = m\vec{a}$	$\vec{F}_g = m\vec{g}$	$\vec{F}_f = \mu\vec{F}_N$	$F_s = -kx$	$\vec{p} = m\vec{v}$	$\vec{J} = \Delta\vec{p}$	$\vec{F}t = m\Delta\vec{v}$	$\vec{p}_{oT} = \vec{p}_{fT}$
$v = \frac{2\pi r}{T}$	$a_c = \frac{v^2}{r}$	$F_c = \frac{mv^2}{r}$	$f = \frac{1}{T}$	$v = \sqrt{rg\mu_s}$	$v = \sqrt{rg \tan \theta}$	$\tau = rF_{\perp}$	$\vec{\tau}_{net} = \sum Torques$		
$\vec{J} = \vec{F}t$		$T = 2\pi\sqrt{\frac{m}{k}}$							
$\vec{J} = \text{Area under F-t curve}$									

Work, Energy, & Power

Symbol	Quantity (Unit)	Symbol	Quantity (Unit)						
<i>W</i>	Work (J)	<i>P</i>	Power (W; Watts)						
<i>W_{nc}</i>	Work by non-conservative force (J)	<i>h</i>	Height above reference (m)						
<i>E_k</i>	Kinetic energy (J)	<i>d</i>	Distance (m)						
<i>E_g</i>	Gravitational potential energy (J)	<i>r</i>	Radius of circle (m)						
<i>E_e</i>	Elastic potential energy (J)	<i>x</i>	Stretch/compression of spring (m)						
<i>E_T</i>	Total mechanical energy (J)								
$W = F_{\parallel}\Delta d$	$E_g = mgh$	$E_k = \frac{1}{2}mv^2$	$E_e = \frac{1}{2}kx^2$	$W = \Delta E_k$	$W = \Delta E_g$	$W = \Delta E_e$	$\Delta E_T = 0$	$W_{nc} = \Delta E_T$	$P = \frac{W}{t}$
$W = \text{Area under F-d curve}$									

Symbol	Quantity (Unit)		Symbol	Quantity (Unit)		Symbol	Quantity (Unit)	
I	Current (A; amperes)		q	Charge (C; coulombs)		t	Time (s)	
N	Number of charges, resistors		e	Elementary Charge (C)		R	Resistance (Ω ; Ohm)	
ρ	Resistivity ($\Omega \cdot m$)		L	Length (m)		A	Cross-sectional area (m^2)	
V, ε	Potential Difference (V; volts)		V_T	Voltage of power source (V)		I_r	Current from power source (A)	
R_{eqs}	Equivalent Resistance-series (Ω)		R_{eqp}	Equivalent Resistance-parallel (Ω)		P	Power (W)	
C_{eqp}	Equivalent capacitance for capacitors in parallel (F)		C_{eqs}	Equivalent capacitance for capacitors in series (F)		τ	Discharge rate (s)	
emf	Electromotive force (V)		r	Internal Resistance (Ω)		E	Electrical energy (J)	
$I = \frac{\Delta q}{\Delta t}$	$q = Ne$	$R = \rho \frac{L}{A}$	$V = IR$	$R_{eqs} = R_1 + R_2 + R_3 + \dots + R_N$	$\frac{1}{R_{eqp}} = \frac{1}{R_1} + \frac{1}{R_2} + \frac{1}{R_3} + \dots + \frac{1}{R_N}$			
$R_{eq} = \frac{V_T}{I_T}$	$P = IV$	$\tau = RC$	$Q(t) = Q_0 e^{-\frac{t}{\tau}}$	$C_{eqp} = C_1 + C_2 + C_3 + \dots + C_N$	$\frac{1}{C_{eqs}} = \frac{1}{C_1} + \frac{1}{C_2} + \frac{1}{C_3} + \dots + \frac{1}{C_N}$			
$I(t) = I_0 e^{-\frac{t}{\tau}}$	$V_{terminal} = emf - Ir$	$Efficiency = \frac{E_{out}}{E_{in}} = \frac{Work}{E_{in}}$						

Gravitational & Electrical Fields

Symbol	Quantity (Unit)		Symbol	Quantity (Unit)		Symbol	Quantity (Unit)	
\vec{F}_q	Electrostatic Force (N)		q	Electric Charge (C)		k	$9.0 \times 10^9 \left(\frac{N \cdot m^2}{C^2}\right)$, Coulomb's constant	
r	Distance from centres (m)		\vec{E}	Electric field intensity ($\frac{N}{C}$)		\vec{g}	Gravitational Field Intensity ($\frac{N}{kg}$)	
\vec{F}_g	Force of gravity (N)		E_g	Gravitational potential energy (J)		E_q	Electric potential energy (J)	
V	Electric potential difference (V)		m	Mass of object (kg)		G	$6.672 \times 10^{-11} \left(\frac{N \cdot m^2}{kg^2}\right)$, Universal gravitational constant	
W	Work (J)		ε_0	8.85×10^{-12} (F/m) Permittivity of free space.		C	Capacitance (F, called farads)	
Q	Charge stored in a capacitor (C)		κ	Dielectric constant (no unit)		d	Plate separation (m)	
A	Plate area (m^2)		E_c	Potential energy in a capacitor (J)				
$\vec{F}_g = G \frac{m_1 m_2}{r^2}$	$\vec{g} = \frac{\vec{F}_g}{m}$	$ \vec{g} = G \frac{m}{r^2}$	$G \frac{m}{r} = v^2$	$\frac{Gm}{4\pi^2} = \frac{r^3}{T^2}$	$E_g = -G \frac{m_1 m_2}{r}$	$\vec{F}_q = k \frac{q_1 q_2}{r^2}$	$\vec{E} = \frac{\vec{F}_q}{q}$	$ \vec{E} = k \frac{q}{r^2}$
$V = \frac{E_q}{q}$	$V = k \frac{q}{r}$	$\Delta E_q = q\Delta V$	$Q = CV$	$C = \frac{\kappa \varepsilon_0 A}{d}$	$E_c = \frac{1}{2} CV^2$	$\vec{E} = \frac{V}{d}$	$E_q = k \frac{q_1 q_2}{r}$	

General Waves & Sound Waves

Symbol	Quantity (Unit)		Symbol	Quantity (Unit)		Symbol	Quantity (Unit)	
T	Period (s)		f	Frequency (Hz)		v	Wave speed (m/s)	
λ	Wavelength (m)		T_{air}	Temp. of air ($^{\circ}$ Celsius)		v_{sound}	Sound speed (m/s)	
v_{src}	Source speed (m/s)		v_{obs}	Observer's speed (m/s)		f_{obs}	Observed frequency (Hz)	
f_{src}	Source frequency (Hz)		F_T	Force of Tension (N)		μ	Mass/unit length (kg/m)	
$T = \frac{\Delta t}{\#waves}$	$f = \frac{\#waves}{\Delta t}$	$T = \frac{1}{f}$	$f = \frac{1}{T}$	$v = f\lambda$	$v = \sqrt{\frac{F_T}{\mu}}$	$v_{sound} = 331 + 0.59T_{air}$	$f_{obs} = f_{src} \left(\frac{v_{sound} \pm v_{obs}}{v_{sound} \mp v_{src}}\right)$	

Refraction

Symbol	Quantity (Unit)	Symbol	Quantity (Unit)	Symbol	Quantity (Unit)
c	3.00×10^8 (m/s), speed of light in a vacuum	v	Speed of light in material (m/s)	n	Index of refraction
n_i	Incident medium index	n_R	Refractive medium index	θ_i	Incident angle (degrees)
θ_R	Refractive angle (degrees)	θ_c	Critical Angle (degrees)	θ_{max}	Max angle refraction (degrees)
$n = \frac{c}{v}$	$n_i \sin \theta_i = n_R \sin \theta_R$	$n_i \sin \theta_c = n_R$	$n_i = n_R \sin \theta_{max}$		

Substance	Index of Refraction (n)
vacuum	1.00000
gases at 0°C, 1.013×10^5 Pa	
hydrogen	1.00014
oxygen	1.00027
air	1.00029
carbon dioxide	1.00045
liquids at 20°C	
water	1.333
ethyl alcohol	1.362
glycerin	1.470
carbon disulfide	1.632

Substance	Index of Refraction (n)
solids at 20°C	
ice (at 0°C)	1.31
quartz (fused)	1.46
optical fibre (cladding)	1.47
optical fibre (core)	1.50
Plexiglas™ or Lucite™	1.51
glass (crown)	1.52
sodium chloride	1.54
glass (crystal)	1.54
ruby	1.54
glass (flint)	1.65
zircon	1.92
diamond	2.42

* Measured using yellow light, with a wavelength of 589 nm in a vacuum.

Optics (Spherical Mirrors & Lenses)

Symbol	Quantity (Unit)	Symbol	Quantity (Unit)	Symbol	Quantity (Unit)
f	Focal length (m, cm, mm)	d_o	Object distance (m, cm, mm)	d_i	Image distance (m, cm, mm)
h_i	Image height (m, cm, mm)	h_o	Object height (m, cm, mm)	M	Magnification
n_{lens}	Lens refractive index	n_o	Surrounding medium refractive index	R	Radius of curvature (m, cm, mm)
$\frac{1}{d_o} + \frac{1}{d_i} = \frac{1}{f}$	$M = \frac{h_i}{h_o}$	$M = -\frac{d_i}{d_o}$	$\frac{h_i}{h_o} = -\frac{d_i}{d_o}$	$\frac{1}{f} = \left(\frac{n_{lens}}{n_o} - 1\right) \left(\frac{1}{R_1} + \frac{1}{R_2}\right)$	

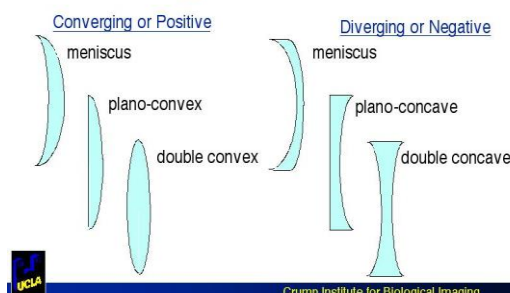
Types of Lenses

Diffraction

Symbol	Quantity (Unit)	Symbol	Quantity (Unit)	Symbol	Quantity (Unit)
m	Maximum # (integer)	λ	wavelength (m)	d	separation of slits (m)
W_m	Distance of maximum from centre (m)	L	Distance from screen (m)	θ	angle (degrees)

$m\lambda = \frac{dW_m}{L}$	$m\lambda = d \sin \theta$	$m\lambda = 2nd$ Above is for thin film interference. n = refractive index of the film
-----------------------------	----------------------------	--

Solar System Data 2009

	Mercury	Venus	Earth	Mars	Jupiter	Saturn	Uranus	Neptune
Distance from sun (million km)	58	108	150	228	778	1,427	2,871	4,500
Radius (km)	2,500	6,052	6,378	3,397	71,492	60,268	25,559	24,764
Diameter (km)	5,000	12,104	12,756	6,794	142,984	120,536	51,118	49,528
Volume (km ³)	6.1×10^{10}	9.2×10^{11}	1.1×10^{12}	1.6×10^{11}	1.4×10^{15}	8.3×10^{14}	6.8×10^{13}	6.3×10^{13}
Mass (kg)	3.3×10^{23}	4.9×10^{24}	6.0×10^{24}	6.4×10^{23}	2.0×10^{27}	5.7×10^{26}	8.7×10^{25}	1.0×10^{26}
Surface gravity (Earth =1)	0.38	0.91	1.00	0.38	2.53	1.08	0.90	1.14
Rotation	58d	243d	24h	24h	10h	11h	17h	16h
Revolution	88d	225d	365d	1.88y	11.9y	29y	84y	164y
Tilt	0.01	177	23.5	25	3	27	98	28
Temperature (°C)	-173 to 427	462	-88 to 58	-87 to -5	-150	-180	-210	-210
Atmosphere	None	CO ₂ , N	N, O	CO ₂ , N, Ar	H, He	H, He	H, He, CH ₃	H, He, CH ₃
Moons	0	0	1	2	62	60	27	13
Rings	No	No	No	No	Yes	Yes	Yes	Yes

Definition of the Quadratic Formula

The quadratic equation is used to solve for the roots of a quadratic function. Given a quadratic equation in the form $ax^2 + bx + c = 0$, where a , b , and c are real numbers and $a \neq 0$, the roots of it can be found using

$$x = \frac{-b \pm \sqrt{b^2 - 4ac}}{2a}$$

Statistical Analysis

In science, data are collected until a trend is observed. Three statistical tools that assist in determining if a trend is developing are *mean*, *median*, and *mode*.

Mean: The sum of the numbers divided by the number of values. It is also called the "average."

Median: When a set of numbers is organized in order of size, the median is the middle number. When the data set contains an even number of values, the median is the average of the two middle numbers.

Mode: The number that occurs most often in a set of numbers. Some data sets will have more than one mode.

Trigonometric Ratios

The ratios of side lengths from a right-angle triangle can be used to define the basic trigonometric function sine (sin), cosine (cos), and tangent (tan).

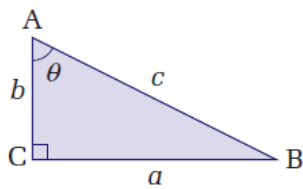

$$\sin \theta = \frac{\text{opposite}}{\text{hypotenuse}}$$

$$\sin \theta = \frac{a}{c}$$

$$\cos \theta = \frac{\text{adjacent}}{\text{hypotenuse}}$$

$$\cos \theta = \frac{b}{c}$$

$$\tan \theta = \frac{\text{opposite}}{\text{adjacent}}$$

$$\tan \theta = \frac{a}{b}$$

The angle selected determines which side will be called the opposite side and which the adjacent side. The hypotenuse is always the side across from the 90° angle. Picture yourself standing on top of the angle you select. The side that is directly across from your position is called the *opposite* side. The side that you could touch and is not the hypotenuse is the *adjacent* side.

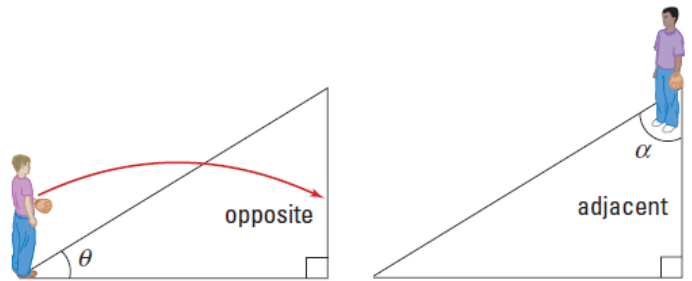

A scientific calculator or trigonometry tables can be used to obtain an angle value from the ratio result. Your calculator performs a complex calculation (Maclaurin series summation) when the \sin^{-1} , or \cos^{-1} , or \tan^{-1} operation is used to determine the angle value. \sin^{-1} is not simply a $1/\sin$ operation.

Definition of the Pythagorean Theorem

The Pythagorean theorem is used to determine side lengths of a right-angle (90°) triangle. Given a right-angle triangle ABC, the Pythagorean theorem states

$$c^2 = a^2 + b^2$$

Quantity	Symbol	SI unit
hypotenuse side is opposite the 90° angle	c	m (metres)
side a	a	m (metres)
side b	b	m (metres)

Note: The hypotenuse is always the side across from the right (90°) angle. The Pythagorean theorem is a special case of a more general mathematical law called the “cosine law.” The cosine law works for all triangles.

Definition of the Cosine Law

The cosine law is useful when

- determining the length of an unknown side given two side lengths and the contained angle between them
- determining an unknown angle given all side lengths

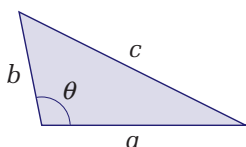

Angle θ is contained between sides a and b .

The cosine law states $c^2 = a^2 + b^2 - 2ab \cos\theta$.

Quantity	Symbol	SI unit
unknown length side c	c	m (metres)
opposite angle θ	c	m (metres)
length side a	a	m (metres)
length side b	b	m (metres)
angle θ opposite unknown side c	θ	(radians)

Note: Applying the cosine law to a right angle triangle, setting $\theta = 90^\circ$, yields the special case of the Pythagorean theorem.

Definition of the Sine Law

The sine law is useful when

- two angles and any one side length are known
- two side lengths and any one angle are known

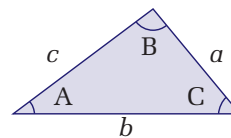

Given any triangle ABC the sine law states

$$\frac{\sin A}{a} = \frac{\sin B}{b} = \frac{\sin C}{c}$$

Quantity	Symbol	SI unit
length side a opposite angle A	a	m (metres)
length side b opposite angle B	b	m (metres)
length side c opposite angle C	c	m (metres)
angle A opposite side a	A	(radians)
angle B opposite side b	B	(radians)
angle C opposite side c	C	(radians)

Note: The sine law generates ambiguous results in some situations because it does not discriminate between obtuse and acute triangles. An example of the ambiguous case is shown below.

Example

Use the sine law to solve for θ .

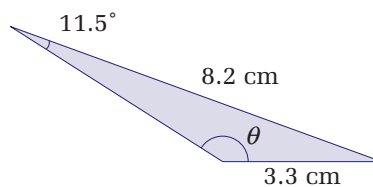

Sine law:
ambiguous case

$$\frac{\sin\theta}{8.2} = \frac{\sin 11.5^\circ}{3.3}$$

$$\sin\theta = 0.5$$

$$\theta = 30^\circ$$

Clearly, angle θ is much greater than 30° . In this case, the supplementary angle is required ($180^\circ - 30^\circ = 150^\circ$). It is important to recognize when dealing with obtuse angles ($> 90^\circ$) that the supplementary angle might be required. Application of the cosine law in these situations will help reduce the potential for error.

Algebra

In some situations, it might be preferable to use algebraic manipulation of equations to solve for a specific variable before substituting numbers. Algebraic manipulation of variables follows the same rules that are used to solve equations after substituting values. In both cases, to maintain equality, whatever is done to one side must be done to the other.

GEOMETRY SHAPES AND SOLIDS

SQUARE

$$P = 4s$$

$$A = s^2$$

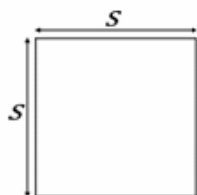

RECTANGLE

$$P = 2a + 2b$$

$$A = ab$$

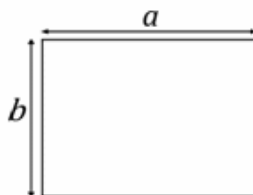

CIRCLE

$$P = 2\pi r$$

$$A = \pi r^2$$

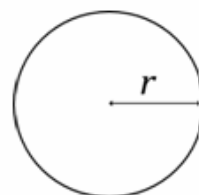

TRIANGLE

$$P = a + b + c$$

$$A = \frac{1}{2}bh$$

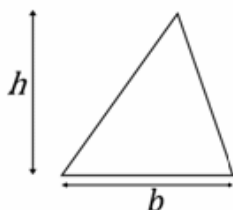

PARALLELOGRAM

$$P = 2a + 2b$$

$$A = bh$$

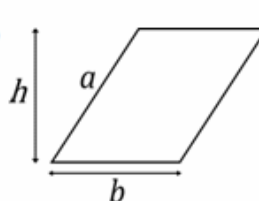

CIRCULAR SECTOR

$$L = \pi r \frac{\theta}{180^\circ}$$

$$A = \pi r^2 \frac{\theta}{360^\circ}$$

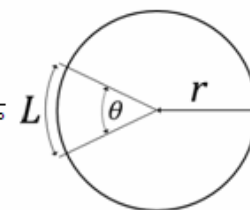

PYTHAGOREAN THEOREM

$$a^2 + b^2 = c^2$$

$$c = \sqrt{a^2 + b^2}$$

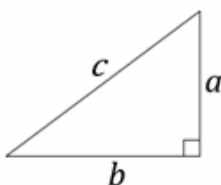

CIRCULAR RING

$$A = \pi(R^2 - r^2)$$

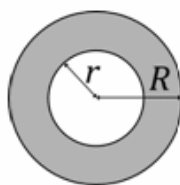

SPHERE

$$S = 4\pi r^2$$

$$V = \frac{4\pi r^3}{3}$$



TRAPEZOID

$$P = a + b + c + d$$

$$A = h \frac{a+b}{2}$$

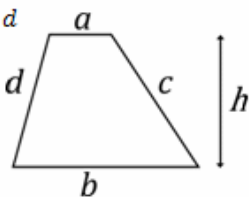

RECTANGULAR BOX

$$A = 2ab + 2ac + 2bc$$

$$V = abc$$

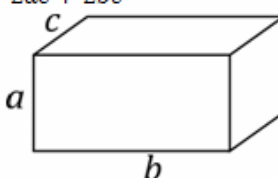

RIGHT CIRCULAR CONE

$$A = \pi r^2 + \pi r s$$

$$s = \sqrt{r^2 + h^2}$$

$$V = \frac{1}{3} \pi r^2 h$$

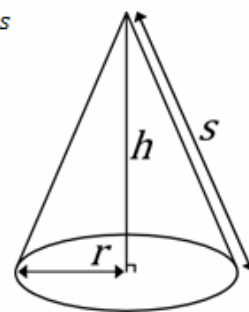

CUBE

$$A = 6l^2$$

$$V = l^3$$

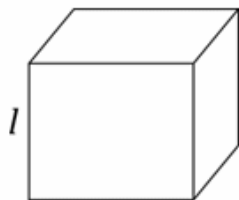

CYLINDER

$$A = 2\pi r(r + h)$$

$$V = \pi r^2 h$$

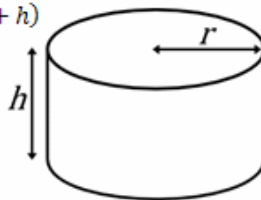

FRUSTUM OF A CONE

$$V = \frac{1}{3} \pi h (r^2 + rR + R^2)$$

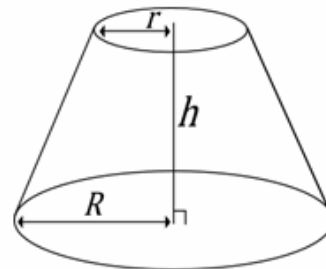

eCalc.com

The Best Online Calculator

- Unit Converter
- RPN and Algebraic Mode
- Constants Library
- Decimal to Fraction
- Polynomial Root Solver
- Simultaneous Equation Solver
- Complex Numbers
- Free Online and Downloadable

The Metric System: Fundamental and Derived Units

Metric System Prefixes

Prefix	Symbol	Factor
tera	T	1 000 000 000 000 = 10^{12}
giga	G	1 000 000 000 = 10^9
mega	M	1 000 000 = 10^6
kilo	k	1000 = 10^3
hecto	h	100 = 10^2
deca	da	10 = 10^1
		1 = 10^0
deci	d	0.1 = 10^{-1}
centi	c	0.01 = 10^{-2}
milli	m	0.001 = 10^{-3}
micro	μ	0.000 001 = 10^{-6}
nano	n	0.000 000 001 = 10^{-9}
pico	p	0.000 000 000 001 = 10^{-12}
femto	f	0.000 000 000 000 001 = 10^{-15}
atto	a	0.000 000 000 000 000 001 = 10^{-18}

Fundamental Physical Quantities and Their SI Units

Quantity	Symbol	Unit	Symbol
length	l	metre	m
mass	m	kilogram	kg
time	t	second	s
absolute temperature	T	Kelvin	K
electric current	I	ampère (amp)	A
amount of substance	mol	mole	mol

Derived SI Units

Quantity	Quantity symbol	Unit	Unit symbol	Equivalent unit(s)
area	A	square metre	m^2	
volume	V	cubic metre	m^3	
velocity	v	metre per second	m/s	
acceleration	a	metre per second per second	m/s^2	
force	F	newton	N	$kg \cdot m/s^2$
work	W	joule	J	$N \cdot m, kg \cdot m^2/s^2$
energy	E	joule	J	$N \cdot m, kg \cdot m^2/s^2$
power	P	watt	W	$J/s, kg \cdot m^2/s^3$
density	ρ	kilogram per cubic metre	kg/m^3	
pressure	p	pascal	Pa	$N/m^2, kg/(m \cdot s^2)$
frequency	f	hertz	Hz	s^{-1}
period	T	second	s	
wavelength	λ	metre	m	
electric charge	Q	coulomb	C	$A \cdot s$
electric potential	V	volt	V	$W/A, J/C,$ $kg \cdot m^2/(C \cdot s^2)$
resistance	R	ohm	Ω	$V/A,$ $kg \cdot m^2/(C^2 \cdot s)$
magnetic field intensity	B	tesla	T	$N \cdot s/(C \cdot m), N/(A \cdot m)$
magnetic flux	Φ	weber	Wb	$V \cdot s, T \cdot m^2, m^2 \cdot kg/(C \cdot s)$
radioactivity	$\Delta N/\Delta t$	becquerel	Bq	s^{-1}
radiation dose		gray	Gy	$J/kg \cdot m^2/s^2$
temperature (Celsius)	T	degree Celsius	$^{\circ}C$	$T^{\circ}C = (T + 273.15) K$
		atomic mass unit	u	$1u = 1.660\ 566 \times 10^{-27} kg$
		electron volt	eV	$1 eV = 1.602 \times 10^{-19} J$

Physical Constants and Data

Fundamental Physical Constants

Quantity	Symbol	Accepted value
speed of light in a vacuum	c	2.998×10^8 m/s
gravitational constant	G	6.673×10^{-11} N · m ² /kg ²
Coulomb's constant	k	8.988×10^9 N · m ² /C ²
charge on an electron	e	1.602×10^{-19} C
rest mass of an electron	m_e	9.109×10^{-31} kg
rest mass of a proton	m_p	1.673×10^{-27} kg
rest mass of a neutron	m_n	1.675×10^{-27} kg
Planck's constant	h	6.626×10^{-34} J · s

Electric Circuit Symbols

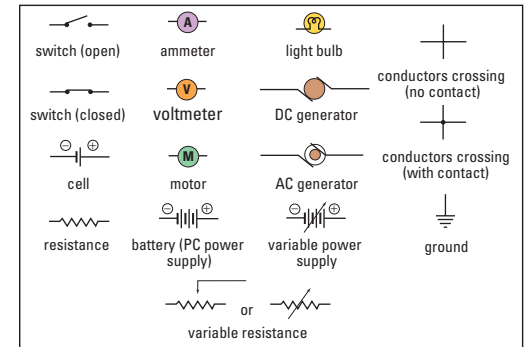

Other Physical Data

Quantity	Symbol	Accepted value
standard atmospheric pressure	P	1.013×10^5 Pa
speed of sound in air		343 m/s (at 20°C)
water: density (4°C)		1.000×10^3 kg/m ³
latent heat of fusion		3.34×10^5 J/kg
latent heat of vaporization		2.26×10^6 J/kg
specific heat capacity (15°C)		4186 J/(kg°C)
kilowatt hour	E	3.6×10^6 J
acceleration due to Earth's gravity	g	9.81 m/s ² (standard value; at sea level)
mass of Earth	m_E	5.98×10^{24} kg
mean radius of Earth	r_E	6.38×10^6 m
mean radius of Earth's orbit	R_E	1.49×10^{11} m
period of Earth's orbit	T_E	365.25 days or 3.16×10^7 s
mass of Moon	m_M	7.36×10^{22} kg
mean radius of Moon	r_M	1.74×10^6 m
mean radius of Moon's orbit	R_M	3.84×10^8 m
period of Moon's orbit	T_M	27.3 days or 2.36×10^6 s
mass of Sun	m_s	1.99×10^{30} kg
radius of Sun	r_s	6.96×10^8 m

Resistor Colour Codes

Colour	Digit represented	Multiplier	Tolerance
black	0	$\times 1$	
brown	1	$\times 1.0 \times 10^1$	
red	2	$\times 1.0 \times 10^2$	
orange	3	$\times 1.0 \times 10^3$	
yellow	4	$\times 1.0 \times 10^4$	
green	5	$\times 1.0 \times 10^5$	
blue	6	$\times 1.0 \times 10^6$	
violet	7	$\times 1.0 \times 10^7$	
gray	8	$\times 1.0 \times 10^8$	
white	9	$\times 1.0 \times 10^9$	
gold		$\times 1.0 \times 10^{-1}$	5%
silver		$\times 1.0 \times 10^{-2}$	10%
no colour			20%

